



Fusion4HomeTM

2G ,3G, 4G Home Signal Booster Kit

User Guide



Table of Contents

Thank you for purchasing SureCall's Fusion4Home cellular signal booster kit. Fusion4Home was specifically designed to eliminate frustrations over dropped calls, limited range and slow data rates by amplifying incoming and outgoing cellular signals in homes up to 2,000 square feet. The Fusion4Home provides enhanced cellular signals for multi-carrier 2G, 3G and 4G voice and data reception. If you have any questions while assembling this kit please contact tech support at 1-888-365-6283 or email us at: support@surecall.com.

Important:

Before installing your booster you need to register it with your carrier. You can do so online at the following urls:

Verizon: <http://www.verizonwireless.com/wcms/consumer/register-signal-booster.html>

AT&T: <https://securec45.securewebsession.com/attsignalbooster.com/>

T-Mobile: <https://www.signalboosterregistration.com/>

Sprint: https://www.sprint.com/legal/fcc_boosters.html

U.S. Cellular: <http://www.uscellular.com/uscellular/support/fcc-booster-registration.jsp>

How It Works _____	Pg. 3
Package Contents _____	Pg. 4-5
Installation Overview _____	Pg. 6
Installing Your Hardware	
Finding the Strongest Signal _____	Pg. 7
Installing the Outside Antenna _____	Pg. 8-9
Installing the Inside Antenna _____	Pg. 10-11
Installing Signal Booster _____	Pg. 12-13
Configure Gain Setting _____	Pg. 14
Troubleshooting _____	Pg. 15-16
Specification _____	Pg. 16
Kitting Information _____	Pg. 17
Warranty _____	Pg. 18-19
Safety Information _____	Pg. 19

SureCall's Fusion4Home is a high-quality bidirectional signal booster that enhances cellular signals to areas that are prone to weak cellular coverage.

Fusion4Home works with two antennas:

- An inside antenna that communicates with your cell phone.
- An outside antenna that communicates with the cell tower.

Signals sent from a cell tower are received by the outside antenna, amplified by the booster and then sent to your phone via the inside antenna. When your phone transmits, the signal is sent to the inside antenna, and then sent to the cell tower via the outside antenna.

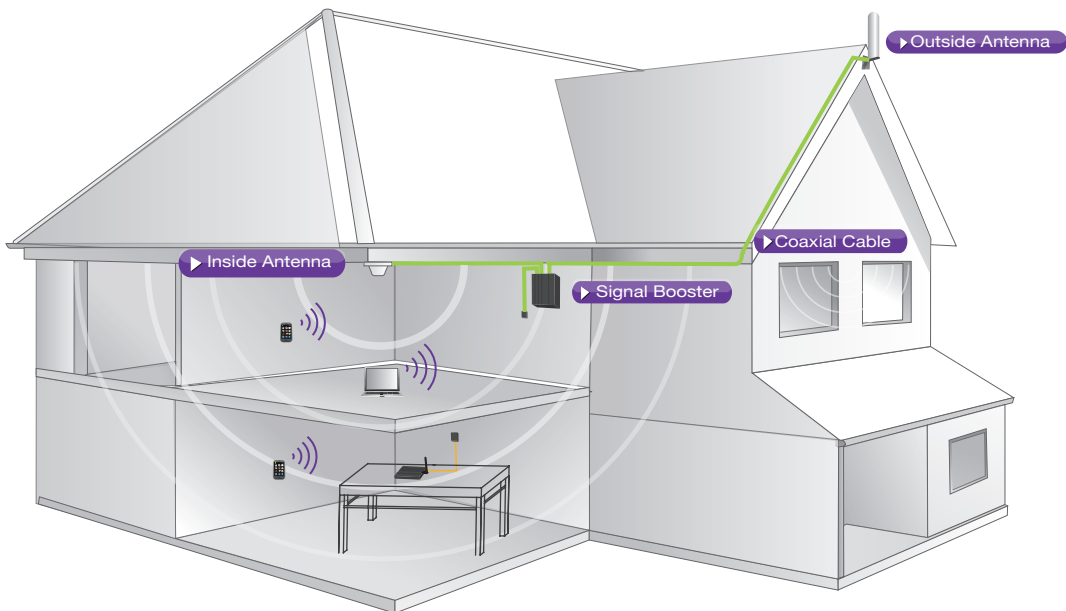

This device may be operated **ONLY** in a fixed location for in-building use

Package Contents

1. Unpack all package contents. For missing or damaged items, contact your reseller.
2. Turn over the signal booster and record the model and serial number for reference:

Serial #: _____

Purchase Date: _____

3. Keep the carton and packing material to store the product in case you need to return it.

Standard Fusion4Home signal booster packages include the following items:

- One SureCall Fusion4Home booster
- One outside antenna
- Cable for connecting the outside antenna to the signal booster
- One inside antenna
- One power supply

Fusion4Home



RG6 Outdoor and SC-240 Indoor Cable

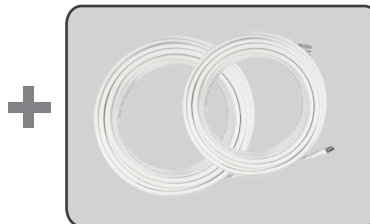

Outside Antenna (Option)



Omni

Yagi

Inside Antenna (Option)

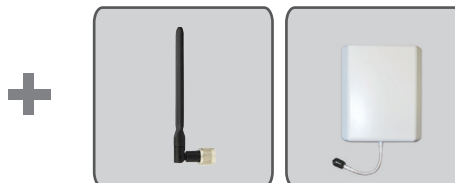

Right Angle





Panel

Warning: Unauthorized antennas, cables, and/or coupling devices are prohibited by FCC new rules. Please contact the FCC for details: 1-888-CALL-FCC. Changes or modifications not expressly approved by SureCall could void the user's authority to operate the equipment.

Note: Fusion4Home is available in three kits that are customized to your particular needs. Please determine which kit you have from the following list:

Model	Package Options
SC-PolyH-72-ORA-CA-Kit	1 Outdoor Omni Antenna, 1 interior right angle antenna and 50' RG6 coax cable
SC-PolyH-72-YRA-CA-Kit	1 Outdoor Yagi Antenna, 1 interior right angle antenna an 50' RG6 coax cable
SC-PolyH-72-YP-CA-Kit	1 Outdoor Yagi Antenna, 1 interior panel antenna, 20' SC-240 and 50' RG6 coax cable

For a detailed description, see Kitting Information on page 15.

	Antenna Type	Model No.	Usage Coverage
	Omni Outdoor Antenna	SC-289W	Omni antennas are ideal for topographies with minimal obstacles, they have 360° reception
	Yagi Outdoor Antenna	SC-231W	Yagi antennas are designed to reach carrier towers that are up to 30 miles away
	Right Angle Antenna	SC-121W	Designed for signal enhancement in 1-2 rooms
	Panel Antenna	SC-248W	Panel Antennas allow optimum reception to targeted areas

Note: Due to the recent change of our company name from Cellphone-Mate (CM) to SureCall (SC) we have changed the prefix on all of our antennas, cables and accessories from CM to SC-.

Before You Install

1. Ensure that you have positioned the booster close enough to an existing electrical outlet.
2. Ensure that there is sufficient cable length between proposed outside antenna location and booster connector.
3. Ensure that you have sufficient cable length between proposed inside antenna location and booster connector. Additional cable may be purchased from your dealer, if needed.

Installation Overview

Step 1. Find the outside area that has the strongest signal. (See page 7 for directions as needed)

Step 2. Install the outside antenna in the area identified in step 1. (See page 8-9 for directions as needed)

Step 3. Install the inside antenna. (See page 10-11 for directions as needed)

Step 4. Mount the signal booster, connect the outside and inside antenna cables to the signal booster, and connect the booster to an AC power source. (See page 12-13 for directions if needed)

Step 5. Configure gain settings on the signal booster if needed. (See page 14 for directions as needed)

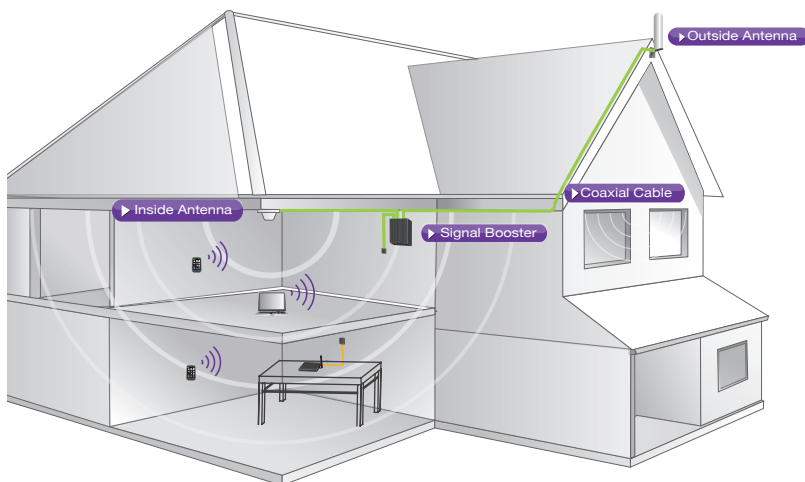

Step 1. Find the area with the Strongest Signal

Before installing the outside antenna, find the area with a strong cellular signal source from your service provider by following the directions below.

Measure the strength of the existing cellular signal in various locations.

- Apple iPhones: Dial *3001#12345#* and press Call. In the top-left corner, a dB number appears instead of bars.
- Android devices: download apps such as “Network Signal Info” in the Google Play store to measure signal strength. Search check real signal strength to find other cell signal measurement apps.
- Internet: go to www.speedtest.net to test 3G and 4G data rates.

The signal booster requires a minimum cellular signal of low -100 dBm. Signal readings usually appear as a negative number (for example, -85). It is recommended that the signal be between -70 dB to -90 dB. That's when the signal is neither too strong nor too weak. Signals stronger than -50 dB may cause the affected bands to shut down while displaying a flashing red LED (see the graph below). If your outside signal is too weak (-95 dB or worse) you may need a Yagi antenna instead of an omnidirectional one, which can be aimed at the cell tower of your carrier to pull in a stronger signal to the booster.

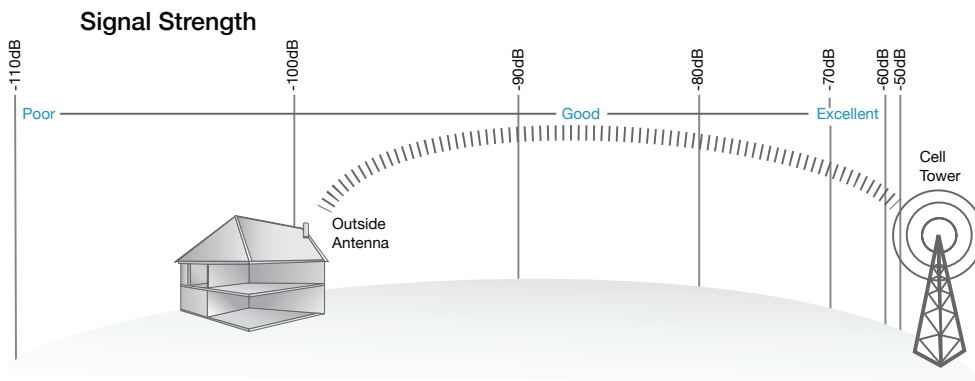

Note: Where you install your outside antenna in relation to the carrier's cell phone tower also determines signal strength. Although cell phone carriers try to place towers for maximum coverage, local ordinances and terrain features can restrict tower locations, which can limit signal strength at your location.

Installing Your Hardware

Step 2. Install the Outside Antenna

1. Outside omni antennas receive and send signals in a 360° radius. Yagi, or directional antennas work best when facing the direction of cellular phone towers. Mount the outside antenna as high as possible. If you are installing a Yagi antenna, mount it facing the nearest cellular tower **being used by your carrier** in the area where you located the best signal source (see step 1 on the previous page).
2. Ensure that the mounting area has at least a 12-inch radius clear of obstructions and other radiating elements.
3. For best performance, place the outside antenna at least 30 feet from the inside antenna. Note that if the mounting area is prone to weak cellular signals or if dense building materials partially block the signal, the booster will operate at its default setting of 65 dB gain.
4. Do not collocate antennas or operate the outside antenna with any other antenna or signal booster.
5. Run the cable from the outside antenna to the signal booster. Hand tighten the connection

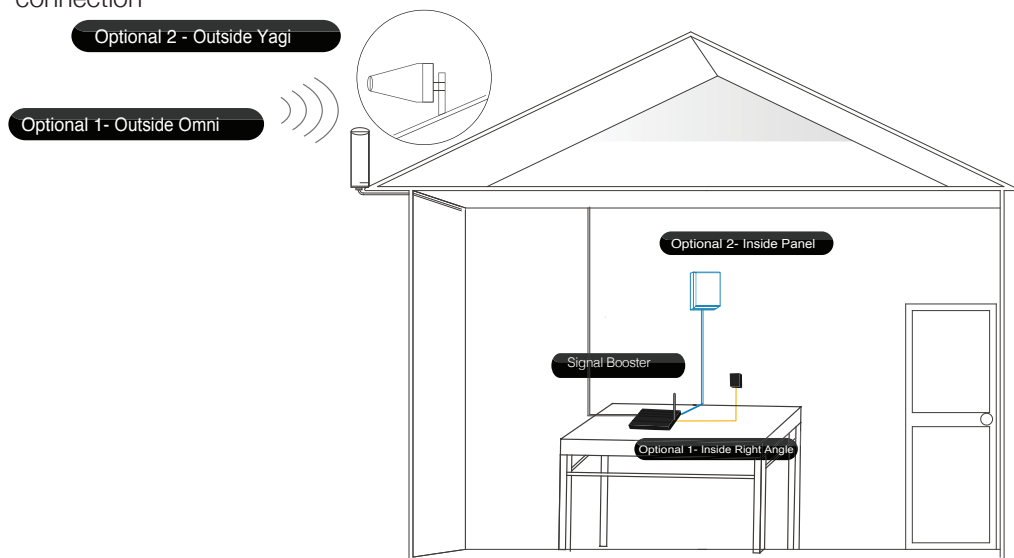

IMPORTANT: FCC 27.5 (d)(4) Statement: Fixed, mobile, and portable (hand-held) stations operating in the 1710-1755 MHz band as well as mobile and portable stations operating in the 1695-1710 MHz and 1755-1780 MHz bands are limited to 1 watt EIRP. Fixed stations operating in the 1710-1755 MHz band are limited to a maximum antenna height of 10 meters above ground. Mobile and portable stations operating in these bands must employ a means for limiting power to the minimum necessary for successful communications.

Installing the Yagi Antenna:

Step 1: Install U-Bolt on pole

Step 2: Slide pipe clamp over U-Bolt with the flat side facing away from the pipe.

Step 3: Slide antenna bracket onto U-Bolt in desired location.

Step 4: Install flat washer, split washer and nut, hand tighten

Note: Antenna may be installed on a variety of pipe angles, ensure that the antenna is pointing in the direction of the closest cellular tower and is vertical with the drip hole at the bottom. To find the location of the closest cell tower go to: www.cellreception.com.

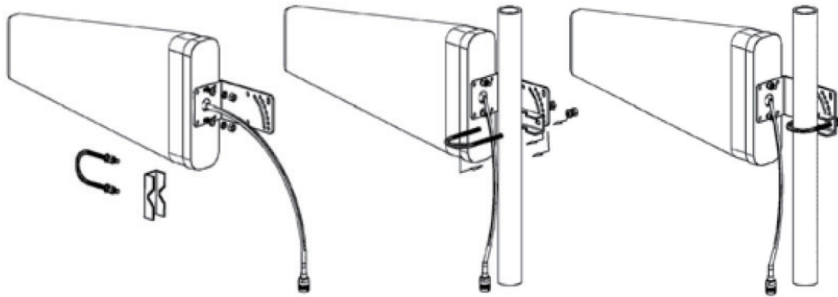

Step 3. Install the Inside Antenna

Inside antennas come in right angle antenna and flat panel versions.

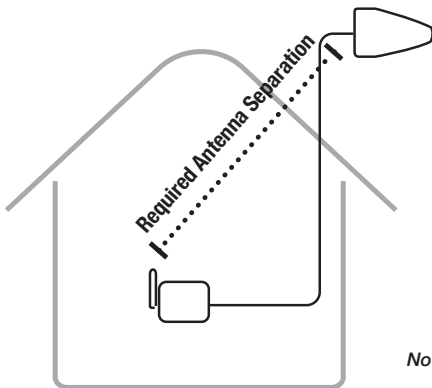

If Coverage Area is ...	And Antenna Separation is...	Set all Dials to...
1500 - 2,000 square feet	40-60 feet	Maximum Power
1,000 - 1,500 square feet	30-40 feet	55 or 60
1,000 square feet and below	20-30 feet	45 or 50

Note: As you can see from the table above, acquiring the recommended inside and outside antenna separation optimizes coverage significantly. Any reduced antenna separation reduces the booster's coverage.

Note: If desired surface for installation plate is wood or concrete, wood or masonry screws for L-plate will have to be purchased separately.

Installing the Panel Antenna:

Connect the antenna by firmly screwing it onto the inside port of the Fusion4Home Booster. For best results, the antenna should be mounted in an upright position. The right angle antenna connects directly to the amplifier port labeled “Inside”.

Step 1. Choose a location for mounting the antenna on vertical surface. Ideal height off the ground or floor should be the approximate height of your cell phone when in use.

Step 2. Using plate, mark position of desired screw placement with pencil or marker.

Step 3. Screw mounting plate into place with the slide panel protruding towards you.

Step 4. Slide antenna securely onto mounting plate.

Note: Be sure to provide enough separation from outside antenna. Panel antenna should not face outside antenna.

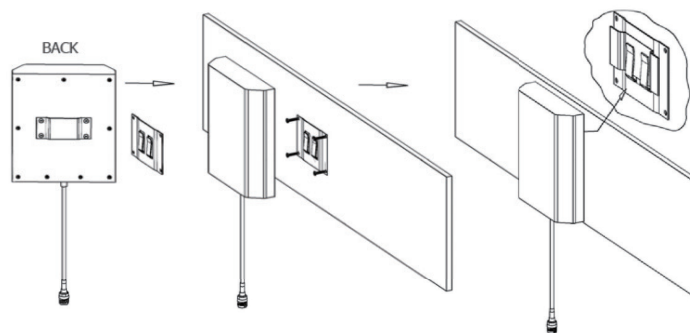

Step 4. Install the Signal Booster

1. Select a location close to a working AC outlet. Do not expose the signal booster to excessive heat, direct sunlight, moisture, and airtight enclosures.
2. If you'd like to mount the booster to a wall, mark location of screw tabs on the wall in the desired location.
3. Use supplied screws or appropriate screws for surface of mounting location and drill through screw tab holes on booster.

4. Connect the outside antenna cable to the signal booster connector marked **OUTSIDE**.
Hand-tighten the connection.
5. Connect the inside antenna cable to the signal booster connector marked **INSIDE**.
Hand-tighten the connection.
6. Connect the AC power cord to the signal booster.
7. Connect the plug on the other end of the 110V AC power outlet.
8. Turn the booster's power switch on.

Booster Hardware

The following image shows the key hardware components on the booster. Refer to this image as you install your Fusion4Home kit components.

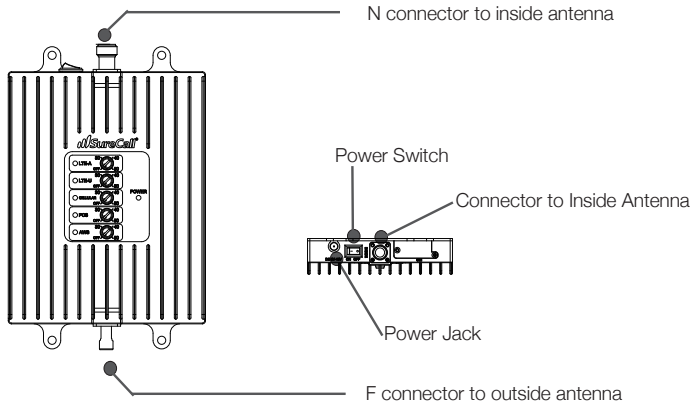

Note: If the Power LED does not turn ON or the Alert LEDs continue to flash, (see PAGES 15-16). This booster is rated for 5-15V input voltage. DO NOT use the booster with a higher voltage power supply. This can damage the booster, cause personal injury, and void your warranty.

Step 5. Configure Gain Settings

The SureCall gain dials should always be at maximum level unless the control light in a specific band is flashing red or flashing red-yellow. In either of these cases, the first action should be to increase the antenna isolation between the inside and outside antenna as much as possible and restart the booster. If the situation continues, you can lower the gain with an attenuator or, as the last resort, reduce the booster gain by 5dB at a time until the control light in the frequency band flashes yellow.

1. Find the PCS, Cellular, LTE-A, LTE-V and AWS dials on top of the signal booster.
2. Set the dials according to the coverage area and the distance between the indoor and outdoor antennas (see below).

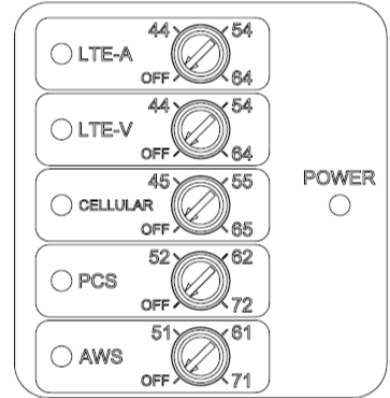

If Coverage Area is ...	And Antenna Separation is...	Set all Dials to...
1500 - 2,000 square feet	40-60 feet	Maximum Power
1,000 - 1,500 square feet	30-40 feet	55 or 60
1,000 square feet and below	20-30 feet	45 or 50

Note: As you can see from the table above, acquiring the recommended indoor and outdoor antenna separation optimizes coverage significantly. Any reduced antenna separation reduces the booster's cellular signal capabilities.

If you Want to Improve Coverage

1. Find a location that receives a stronger signal and relocate the outside antenna to that location or, for the Yagi antenna, optimize the antenna angle.
2. Increase the distance between the outside and inside antennas.
3. Be sure your signal booster's dB gain is turned up to maximum gain on each dial.

WARNING: Do not attenuate the uplink and downlink dB settings below 35dB. This could cause the affected frequency band to shut down.

In the event you encounter a problem, follow the suggestions below to resolve the issue.

Troubleshooting

Problem	Resolution
Signal booster has no power	<p>Verify that the switch on the power supply is turned on and red LED is ON.</p> <p>Connect the power supply to an alternate power source.</p> <p>Be sure the power source is not controlled by a switch that can remove power from the outlet.</p> <p>Check the green POWER LED on the signal booster. If it is OFF, return the power supply to SureCall.</p> <p>Contact tech support at 1-888-365-6283 or support@surecall.com, or go to www.surecall.com and log on to online support to receive an RMA.</p>
After installing your signal booster system, you have no signal or reception.	<p>Cable connections should be tightly fitted to the booster and antenna.</p> <p>There should be no flashing or solid red LEDs as well as no lights flashing rapidly between two colors.</p> <p>Be sure your signal booster's dB gain is turned up to full power on each dial.</p>

LED Indicators

LED Color	LED Condition	Resolution
Red	Solid	<p>Band is off.</p> <p>If a red light has been flashing for an extended time, the band will automatically shut off and display a solid red light.</p> <p>This can also happen when the booster attenuation has been turned all the way down.</p>
Red	Flashing	<p>Indicates that the booster is receiving too much signal which could cause the affected band to automatically turn off. When this happens:</p> <ol style="list-style-type: none"> For kits using an OMNI outside antenna, relocate the outside antenna to a location where the signal is weaker. For kits using a YAGI outside antenna, turn the antenna in short increments away from the signal source. Increase the separation between antennas (additional vertical separation works best). Add an inline attenuator to the cable coming into the outside port of the booster. As a last resort, turn down the dB gain on the dial until the light goes OFF or flashes yellow.
Yellow	Flashing	<p>Indicates that the Automatic Gain Control (AGC) is self-adjusting. This is part of normal operation.</p>
Yellow	Solid	<p>Indicates that the band is inactive. Light is off while band is active.</p>
Yellow/Red	Alternately Flashing	<p>Oscillation is detected.</p> <p>First, try increasing the separation between the inside and outside antennas. If your booster kit uses two directional antennas (example: outside Yagi antenna and inside panel antenna), ensure that they are facing away from one another.</p> <p>If oscillation continues, lower the dB gain in small increments until the light turns off or flashes yellow.</p>

If you Want to Improve Coverage

1. Find a location that receives a stronger signal and relocate the outside antenna to that location.
2. Optimize the Yagi antenna angle.
3. Increase the distance between the outside antenna and booster.
4. Set each dial on the booster to maximum gain.

WARNING: Do not attenuate the uplink and downlink dB settings below 35dB. This could cause the affected frequency band to shut down.

Fusion4Home Specifications	
Uplink Frequency Range (MHz):	698-716 / 776 – 787 / 824-849 1850-1915 / 1710-1755 (G Block Included)
Downlink Frequency Range (MHz):	728-746 / 746 – 757 / 869-894 1930-1995 / 2110-2155 (G Block Included)
Input Impedance:	75Ω donor port / 50Ω server port
Maximum Gain:	72 dB
Noise Figure:	8 dB
Supported Standards:	CDMA, WCDMA, GSM, EDGE, HSPA+, EVDO, LTE and all cellular standards
AC Input:	Input AC110V, 60 Hz; Output DC 5-15V
Maximum Output Power:	1 Watt EIRP
Cable:	RG6 / SC-240
RF Connectors:	N Female (both ends)
Power Consumption:	<15W
Operation Temperature:	-4° to +158° F
Dimensions:	7.875 x 5 x 1.188 inches
Weight:	2 LB 3 oz
FCC ID / IC:	RSNFUSION4H / 7784A-FUSION4H

Kitting Information

Component	Product number	Gain/Loss					Note
		LTE-A	LTE-V	800 MHz	1900 MHz	1700 / 2100 MHz	
Outdoor Antenna*	SC-289W-75Ω	3 dBi	3 dBi	3 dBi	4 dBi	4 dBi / 4 dBi	
	SC-231W-75Ω	7 dBi	7 dBi	8 dBi	10 dBi	10 dBi / 10 dBi	
Outdoor Cable*	RG6 - 50 (50')	3.32 dB	3.32 dB	3.75 dB	6.42dB	6.22 dB / 6.68 dB	50 Feet or longer
Inside Cable*	SC-240-20NN (20')	2.06 dB	2.06 dB	2.29 dB	3.56 dB	3.36 dB / 3.76 dB	20 Feet or longer
Inside Antenna*	SC-248W	7 dBi	7 dBi	7 dBi	10 dBi	10 dBi / 10 dBi	
	SC-222W	3 dBi	3 dBi	3 dBi	6 dBi	6 dBi / 6 dBi	
	SC-121W	1.2 dBi	1.2 dBi	1.2 dBi	3 dBi	3 dBi / 3 dBi	
	SC-302W	2.5 dBi	2.5 dBi	3 dBi	5 dBi	4 dBi / 5 dBi	
* All equivalent antennas and cables are suitable for use with the Fusion4Home							

La puissance de sortie nominale indiquée par le fabricant pour cet appareil concerne son fonctionnement avec porteuse unique. Pour des appareils avec porteuses multiples, on doit réduire la valeur nominale de 3,5 dB, surtout si le signal de sortie est retransmis et qu'il peut causer du brouillage aux utilisateurs de bandes adjacentes. Une telle réduction doit porter sur la puissance d'entrée ou sur le gain, et ne doit pas se faire au moyen d'un atténuateur raccordé à la sortie du dispositif.

This Class A digital apparatus meets all requirements of the Canadian Interference Causing Equipment Regulations. Operation is subject to the following two conditions; (1) this device digital apparatus meets all requirements of the Canadian Interference Causing Equipment Regulations. Operation is subject to the following two conditions; (1) this device may not cause harmful interference, and (2) this device must accept any interference received, including interference that may cause undesired operation

Cet appareillage numérique de la classe A répond a toutes les exigences de l'interférence canadienne causant des règlements d'équipement. L'opération est sujette aux deux conditions suivantes: (1) ce dispositif peut ne pas causer l'interférence nocive, et (2) ce dispositif doit accepter n'importe quelle interférence reçue, y compris l'interférence qui peut causer l'opération peu désirée.

Three-Year Product Warranty

SureCall warrants its products for three years from the date of purchase against defects in workmanship and/or materials. Specifications are subject to change. The three-year warranty only applies to products meeting the latest FCC Certification Guidelines stated on 2/20/2013 and going into effect April 30, 2014. A two-year warranty applies to any products manufactured before May 1, 2014.

Products returned by customers must be in their original, un-modified condition, shipped in the original or protective packaging with proof-of-purchase documentation enclosed, and a Return Merchandise Authorization (RMA) number printed clearly on the outside of the shipping container.

Buyers may obtain an RMA number for warranty returns by calling the SureCall Return Department toll-free at 1-888-365-6283. Any returns received by SureCall without an RMA number clearly printed on the outside of the shipping container will be returned to sender. In order to receive full credit for signal boosters, all accessories originally included in the signal booster box must be returned with the signal booster. (The Buyer does not need to include accessories sold in addition to the signal booster, such as antennas or cables.)

This warranty does not apply to any product determined by SureCall to have been subjected to misuse, abuse, neglect, or mishandling that alters or damages the product's physical or electronic properties.

SureCall warrants to the Buyer that each of its products, when shipped, will be free from defects in material and workmanship, and will perform in full accordance with applicable specifications. The limit of liability under this warranty is, at SureCall's option, to repair or replace any product or part thereof which was purchased up to THREE YEARS after May 1, 2014 or TWO YEARS for products purchased before May 1, 2014, as determined by examination by SureCall, prove defective in material and/or workmanship. Warranty returns must first be authorized in writing by SureCall. Disassembly of any SureCall product by anyone other than an authorized representative of SureCall voids this warranty in its entirety. SureCall reserves the right to make changes in any of its products without incurring any obligation to make the same changes on previously delivered products.

As a condition to the warranties provided for herein, the Buyer will prepay the shipping charges for all products returned to SureCall for repair, and SureCall will pay the return shipping with the exception of products returned from outside the United States, in which case the Buyer will pay the shipping charges.

The Buyer will pay the cost of inspecting and testing any goods returned under the warranty or otherwise, which are found to meet the applicable specifications or which are not defective or not covered by this warranty.

Products sold by SureCall shall not be considered defective or non-conforming to the Buyer's order if they satisfactorily fulfill the performance requirements that were published in the product specification literature, or in accordance with samples provided by SureCall. This warranty shall not apply to any products or parts thereof which have been subject to accident, negligence, alteration, abuse, or misuse. SureCall makes no warranty whatsoever in respect to accessories or parts not supplied by it.

Limitations of Warranty, Damages and Liability:

EXCEPT AS EXPRESSLY SET FORTH HEREIN, THERE ARE NO WARRANTIES, CONDITIONS, GUARANTEES, OR REPRESENTATIONS AS TO MERCHANTABILITY, FITNESS FOR A PARTICULAR PURPOSE, OR OTHER WARRANTIES, CONDITIONS, GUARANTEES, OR REPRESENTATIONS, WHETHER EXPRESSED OR IMPLIED, IN LAW OR IN FACT, ORAL OR IN WRITING. SURECALL AGGREGATE LIABILITY IN DAMAGES OR OTHERWISE SHALL NOT EXCEED THE PAYMENT, IF ANY, RECEIVED BY CELLPHONE-MATE, INC. FOR THE UNIT OF PRODUCT OR SERVICE FURNISHED OR TO BE FURNISHED, AS THE CASE MAY BE, WHICH IS THE SUBJECT OF CLAIM OR DISPUTE. IN NO EVENT SHALL SURECALL BE LIABLE FOR INCIDENTAL, CONSEQUENTIAL, OR SPECIAL DAMAGES, HOWSOEVER CAUSED.

All matters regarding this warranty shall be interpreted in accordance with the laws of the State of California, and any controversy that cannot be settled directly shall be settled by arbitration in California in accordance with the rules then prevailing of the American Arbitration Association, and judgment upon the award rendered may be entered in any court having jurisdiction thereof. If one or more provisions provided herein are held to be invalid or unenforceable under applicable law, then such provision shall be ineffective and excluded to the extent of such invalidity or unenforceability without affecting in any way the remaining provisions hereof.

SAFETY INFORMATION

This is a CONSUMER device.

BEFORE USE, you MUST REGISTER THIS DEVICE with your wireless provider and have your provider's consent. Most wireless providers consent to the use of signal boosters. Some providers may not consent to the use of this device on their network. If you are unsure, contact your provider. You MUST operate this device with approved antennas and cables as specified by the manufacturer. Antennas MUST be installed at least 20 cm (8 inches) from any person. You MUST cease operating this device immediately if requested by the FCC or a licensed wireless service provider.

WARNING: E911 location information may not be provided or may be inaccurate for calls served BY USING THIS DEVICE.

48346 Millmont Drive
Fremont, California 94538
USA
888.365.6283
Fax: 510.996.7250
www.surecall.com

SureCall has made a good faith effort to ensure the accuracy of the information in this document and disclaims the implied warranties of merchantability and fitness for a particular purpose and makes no express warranties, except as may be stated in its written agreement with and for its customers. SureCall shall not be held liable to anyone for any indirect, special or consequential damages due to omissions or errors. The information and specifications in this document are subject to change without notice. © 2014. All Rights Reserved. All trademarks and registered trademarks are the property of their respective owners.

This is a **CONSUMER** device.

BEFORE USE, you **MUST REGISTER THIS DEVICE** with your wireless provider and have your provider's consent. Most wireless providers consent to the use of signal boosters. Some providers may not consent to the use of this device on their network. If you are unsure, contact your provider.

You **MUST** operate this device with approved antennas and cables as specified by the manufacturer. Antennas **MUST** be installed at least 20 cm (8 inches) from any person. You **MUST** cease operating this device immediately if requested by the FCC or a licensed wireless service provider.

WARNING. E911 location information may not be provided or may be inaccurate for calls served by using this device.

This device may be operated **ONLY** in a fixed location for in-building use.

Note: This equipment has been tested and found to comply with the limits for a Class B digital device, pursuant to part 15 of the FCC Rules. These limits are designed to provide reasonable protection against harmful interference in a residential installation. This equipment generates, uses and can radiate radio frequency energy and, if not installed and used in accordance with the instructions, may cause harmful interference to radio communications. However, there is no guarantee that interference will not occur in a particular installation. If this equipment does cause harmful interference to radio or television reception, which can be determined by turning the equipment off and on, the user is encouraged to try to correct the interference by one or more of the following measures:

- Reorient or relocate the receiving antenna.
- Increase the separation between the equipment and receiver.
- Connect the equipment into an outlet on a circuit different from that to which the receiver is connected.
- Consult the dealer or an experienced radio/TV technician for help.

FCC 27.50(d)(4) Statement: Fixed, mobile and portable (hand-held) stations operating in the 1720-1755 MHz band are limited to 1 Watt EIRP. Fixed stations operating in this band are limited to a maximum antenna height of 10 meters above ground. Mobile and portable stations operating in this band must employ a means for limiting power to the minimum necessary for successful communications.